



FEDERATION INTERNATIONALE
DE L'AUTOMOBILE
JAPAN AUTOMOBILE FEDERATION
社団法人 日本自動車連盟

Groupe / Group / グループ

N

Homologation N°

N-5714

Extension N°

08/04 VO

NON VALABLE EN SUPER PRODUCTION
NOT VALID IN SUPER PRODUCTION

JAF公認番号 FN-085 VO-5/3

JAF発効日 2008年7月1日

FICHE D'EXTENSION D'HOMOLOGATION
HOMOLOGATION EXTENSION FORM

追加公認書式

- | | | | |
|-----------------------------|---|--|--|
| <input type="checkbox"/> ES | Evolution sportive du type / Sporting evolution of the type
スポーツ進化 | <input checked="" type="checkbox"/> VO | Variante option / Option variant
オプション変型 |
| <input type="checkbox"/> ET | Evolution normale du type / Normal evolution of the type
型式の正常進化 | <input type="checkbox"/> VP | Variante de Production / Production variant
プロダクション変型 |
| <input type="checkbox"/> VF | Variante de fourniture / Supply variant
供給変型 | <input type="checkbox"/> ER | Erratum / Erratum
誤記訂正 |

Véhicule : Constructeur

Vehicle : Manufacturer

車両 : 製造会社名

FUJI HEAVY INDUSTRIES LTD.

Modèle et type

Model and type

モデルと型式

SUBARU IMPREZA WRX STI (2007) , GRB

Homologation valable à partir du

Homologation valid as from

FIA公認発効年月日

01 OCT. 2008

COPY

Page or ext. 頁または追加番号	Article 項目	Description 記述
	9	<p>BODYWORK</p> <p>Removable unused supports (Any other parts than parts listed on page 2 may not be removed)</p>



Fédération Internationale de l'Automobile
Chemin de Blandonnet, 2
CH-1215 GENEVE 15
Tél. +41 22 544 44 00
Fax Sport +41 22 544 44 50

Marque
Make
会社名 FUJI

Modèle
Model
行名 GRB

Homologation N°

N-5714

Extension N°

08/04 VO

JAF公認番号 FN-085 VO-5/3

Page or ext. 頁または追加番号	Article 項目	Description 記述		
Photo No.	PART NAME	PART No.	FOR	MASS(kg)
0805301 1 / 2	BRKT OUT TEMP	53051FE000	Temperature sensor	0.024
0805302_1	BRKT INPN CTR CP & BRKT CP EVAPO	-	Floor carpet & Air conditioner	-
0805302 2	BRKT INPN CTR CP	52730TC040	Floor carpet	0.024
0805302 3	BRKT CP EVAPO	52230AG090	Air conditioner	0.01
0805303 1 / 2	BRKT FOOT REST CP RHD	52230AG170	Foot rest	0.044
0805304 1 / 2	BRKT MAP LAMP	53720FG010	Map lamp	0.122
0805305_1 / 2	PLATE ANCHOR CP LH	52135AG160	Rear seat belts	0.29
	PLATE ANCHOR CP RH	52135AG060	Rear seat belts	0.29
0805306 1	HOOK TIE DOWN R (LHside)	57801FG000	Tie down	0.26
0805306 2	HOOK TIE DOWN R (RHside)	57801FG000	Tie down	0.26
0805306 1 / 2	HOOK TIE DOWN R (LHside & RHside)	-	Tie down	-
0805307 1 / 2	BRKT CANISTER	52152FG020	Canister	0.064
0805308 1	REINF SP TIRE CP & BRKT SP TIRE CP	-	Canister	-
0805308 2	REINF SP TIRE CP	52143FG000	Spare tyre	0.424
0805308 3	BRKT SP TIRE CP	52152FG000	Spare tyre	0.216
0805309 1 / 2	PATCH CRSMBR B CP	52136AG210	Rear seat	0.036
0805310 1	BRKT ECU B (LHside)	53230TC180	Inner trims	0.012
0805310 2	BRKT ECU B (RHside)	53230TC180	Inner trims	0.012
0805310 3	BRKT ECU B (RHside & LHside)	-	Inner trims	-
0805311 1 / 2	REINF RETRACTER	51572FG100	Rear seat belts	0.036
0805312 1	BRKT TRIM R QTR (RHside)	51562FG040	Inner trims	0.038
0805312 2	BRKT TRIM R QTR (LHside)	51562FG040	Inner trims	0.038
0805312 3	BRKT TRIM R QTR (RHside & LHside)	-	Inner trims	-
0805313_1	BRKT MUF A + HOOK MUF CTR & BRKT MUF B + HOOK MUF B (LHside)	-	Exhaust pipe	-
0805313_2	BRKT MUF A (LHside)	52153FG000	Exhaust pipe	0.102
	HOOK MUF CTR (LHside)	52148AF000		
0805313_3	BRKT MUF B (LHside)	52153FG030	Exhaust pipe	0.138
	HOOK MUF B (LHside)	52148FG010		
0805314_1	BRKT MUF A + HOOK MUF CTR & BRKT MUF B + HOOK MUF B (RHside)	-	Exhaust pipe	-
0805314_2	BRKT MUF A (RHside)	52153FG000	Exhaust pipe	0.102
	HOOK MUF CTR (RHside)	52148AF000		
0805314_3	BRKT MUF B (RHside)	52153FG020	Exhaust pipe	0.138
	HOOK MUF B (RHside)	52148FG010		
			TOTAL	2.68



Fédération Internationale de l'Automobile

Chemin de Blandonnet, 2
CH-1215 GENEVE 15

Tél.: 41 22 544 44 00

Fax Sport: 41 22 544 44 50

Marque
Make
会社名 FUJI

Modèle
Model
行名 GRB

Homologation N°

N-5714

Extension N°

08/04 VO

JAF公認番号

FN-085 VO-5/3

PHOTO N° 0805301_1

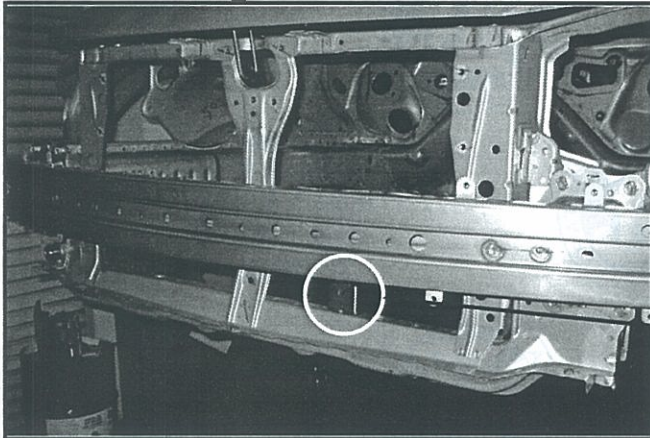

PHOTO N° 0805301_2

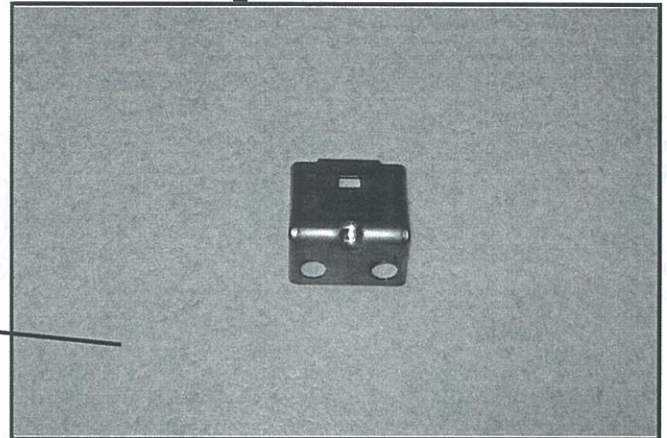

PHOTO N° 0805302_1

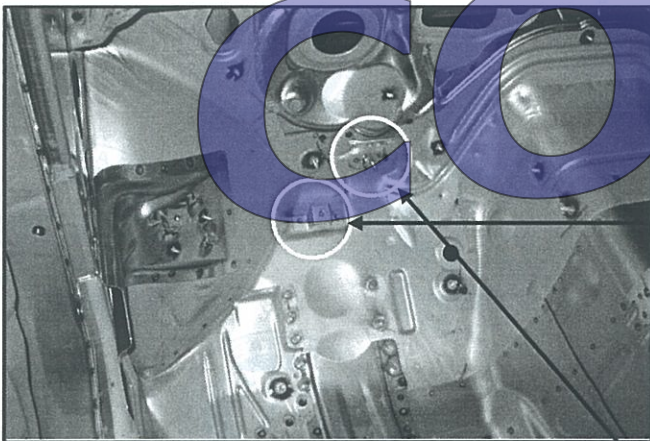

PHOTO N° 0805302_2

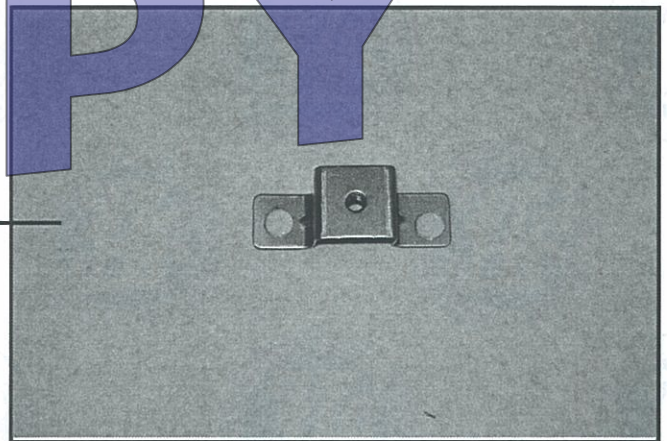

PHOTO N°

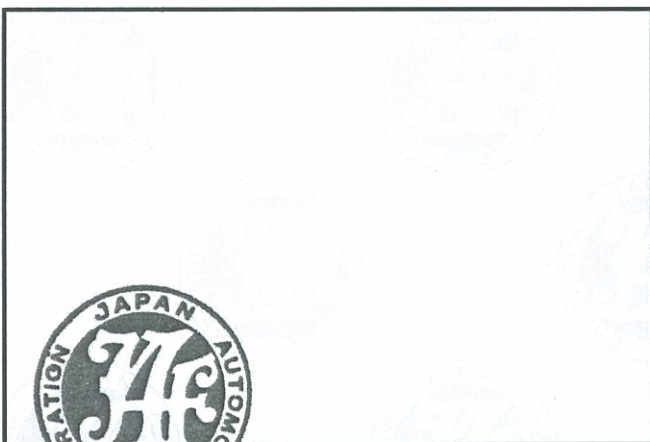

PHOTO N° 0805302_3



Fédération Internationale de l'Automobile
Chemin de Blandonnet, 2

CH-1215 GENEVE 15
Tél.: 41 22 544 44 00
Fax Sport: 41 22 544 44 50

Marque
Make
会社名 FUJI

Modèle
Model
行名 GRB

Homologation N°

N-5714

Extension N°

08/04 VO

JAF公認番号

FN-085 VO-5/3

PHOTO N° 0805303_1

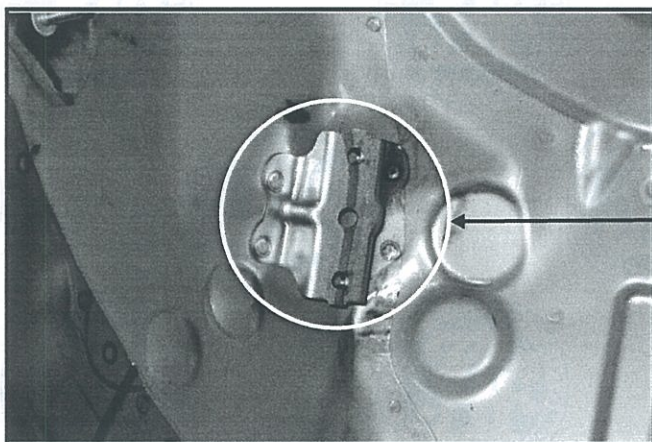

PHOTO N° 0805303_2

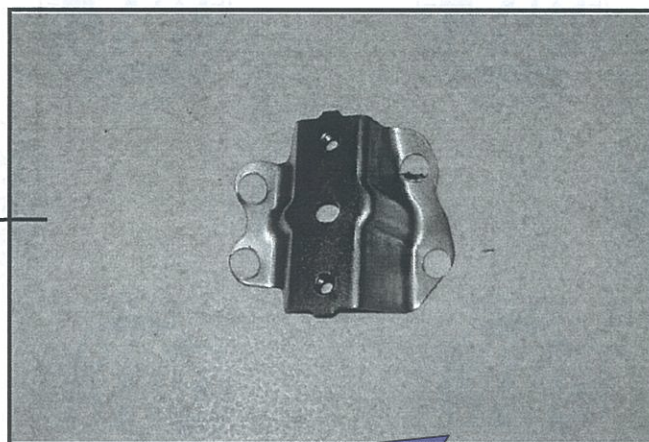

PHOTO N° 0805304_1

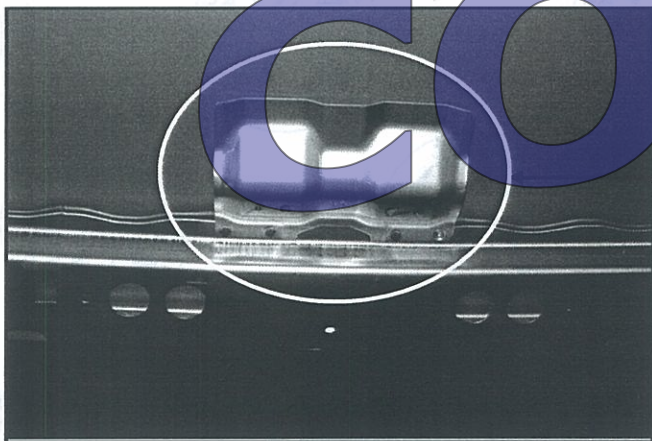

PHOTO N° 0805304_2

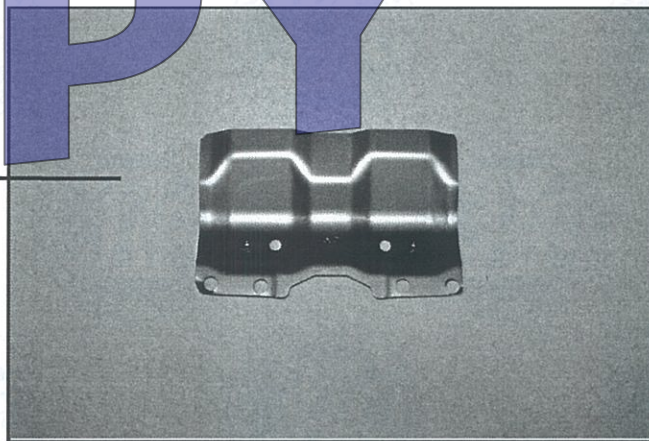

PHOTO N° 0805305_1

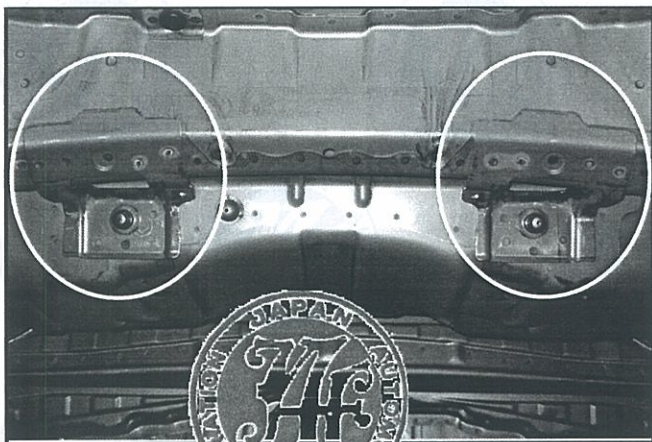
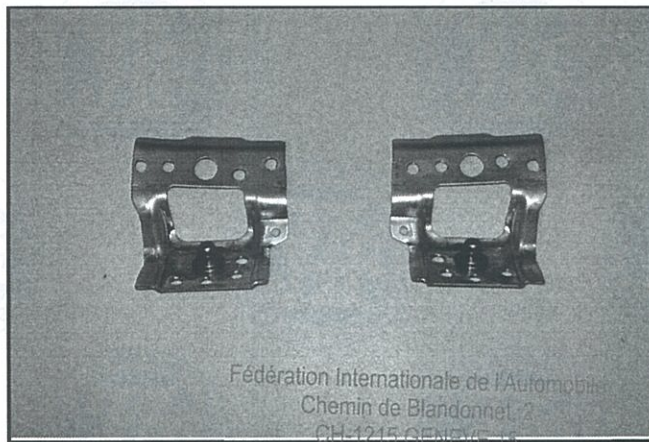

PHOTO N° 0805305_2



Fédération Internationale de l'Automobile
Chemin de Blandonnet, 2
CH-1215 GENEVE 15
Tél.: 41 22 544 44 00
Fax Sport: 41 22 544 44 50

Marque
Make
会社名 FUJI

Modèle
Model
行名 GRB

Homologation N°

N-5714

Extension N°

08/04 VO

JAF公認番号

FN-085 VO-5/3

PHOTO N° 0805306_1

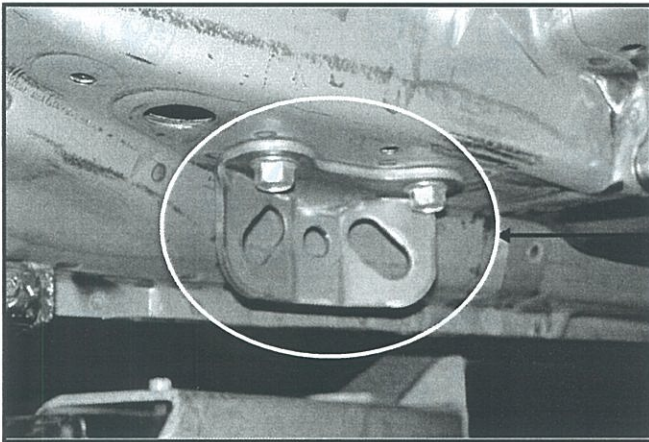

PHOTO N° 0805306_3

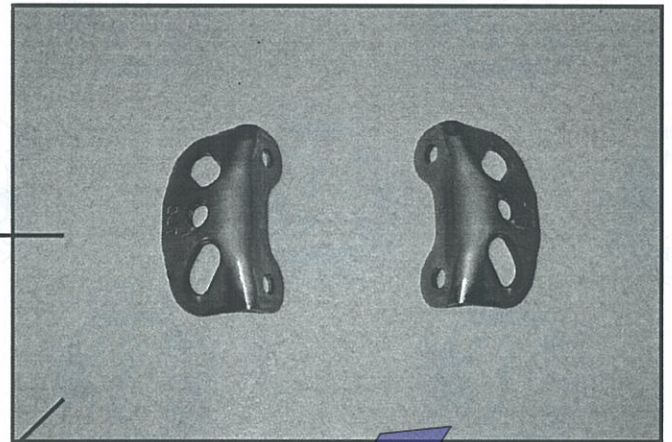

PHOTO N° 0805306-2

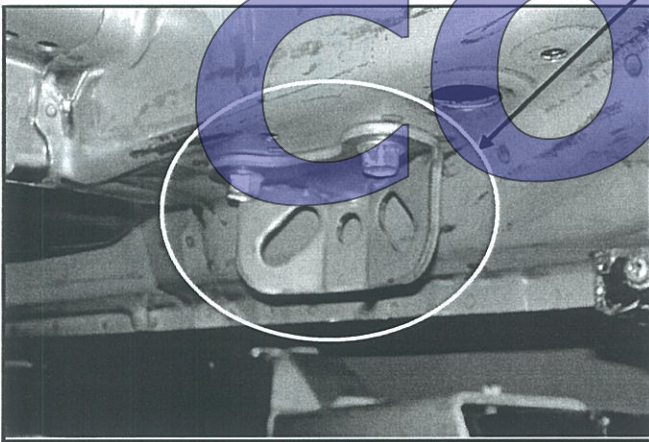

PHOTO N°

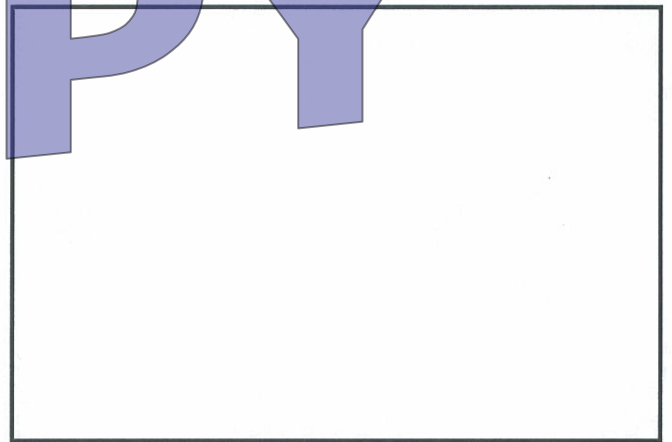

PHOTO N° 0805307_1

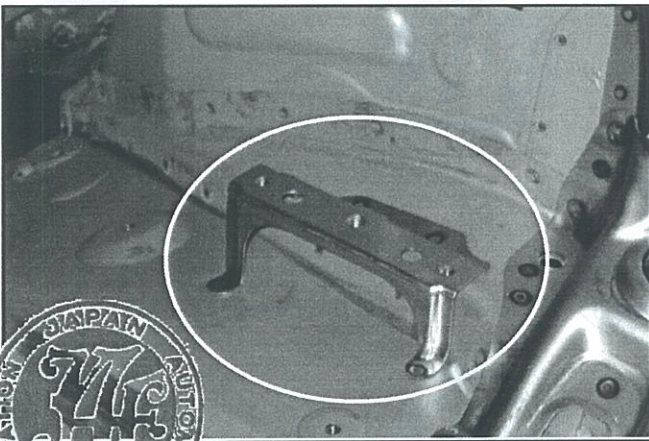
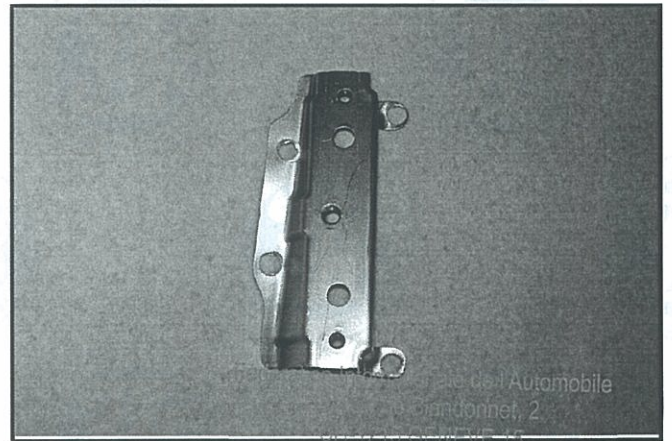

PHOTO N° 0805307_2



Tél.: 41 22 544 44 00
Fax Sport: 41 22 544 44 50

Marque
Make
会社名 FUJI

Modèle
Model
行名 GRB

Homologation N°

N-5714

Extension N°

08/04 VO

JAF公認番号

FN-085 VO-5/3

PHOTO N° 0805308_1

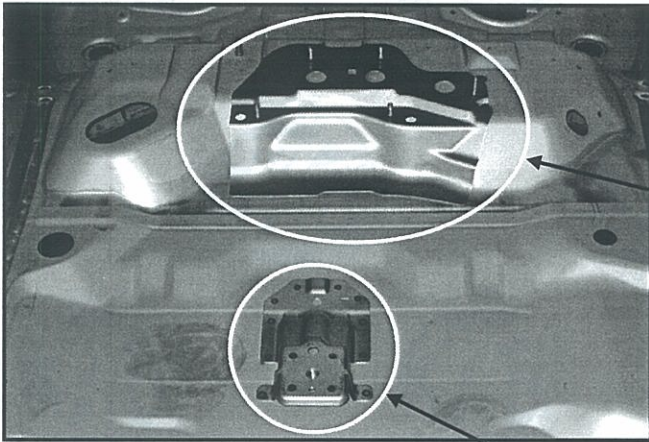

PHOTO N° 0805308_2

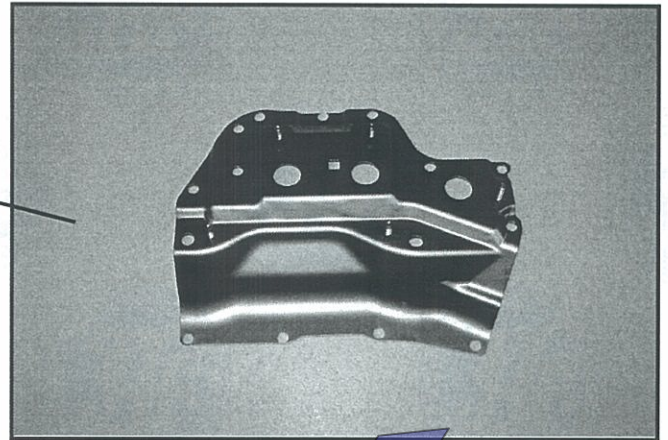

PHOTO N°

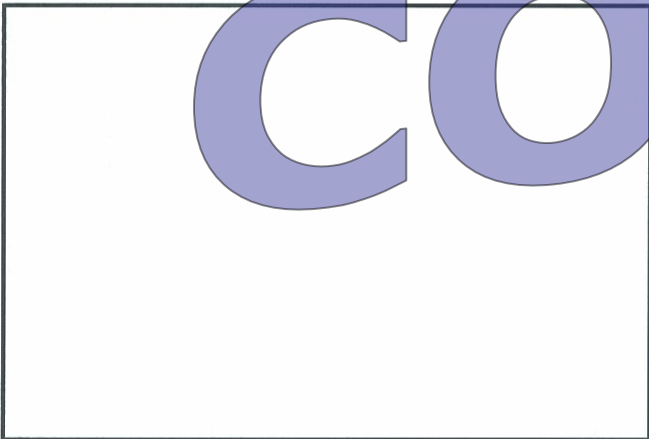

PHOTO N° 0805308_3

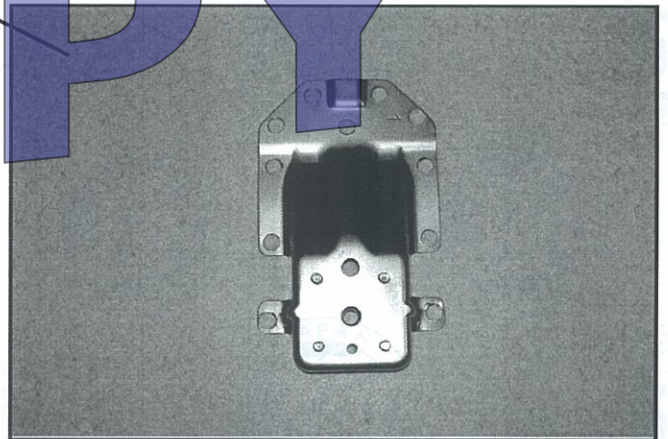

PHOTO N° 0805309_1

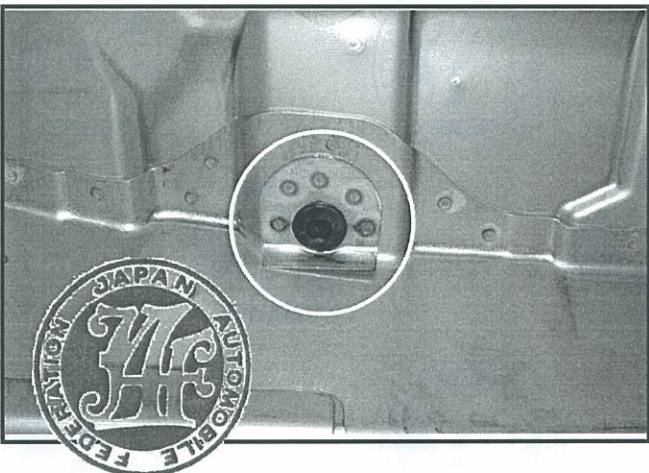
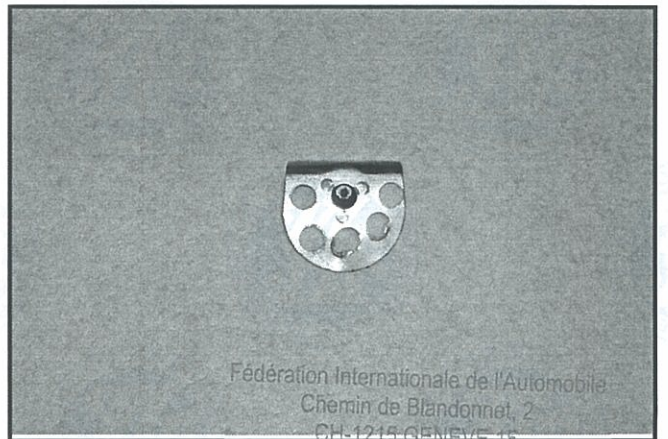

PHOTO N° 0805309_2



Fédération Internationale de l'Automobile
Chemin de Blandonnet, 2
CH-1215 GENEVE 15
Tél.: 41 22 544 44 00
Fax Sport: 41 22 544 44 50

Marque
Make
会社名 FUJI

Modèle
Model
行名 GRB

Homologation N°

N-5714

Extension N°

08/04 VO

JAF公認番号

FN-085 VO-5/3

PHOTO N° 0805310_1

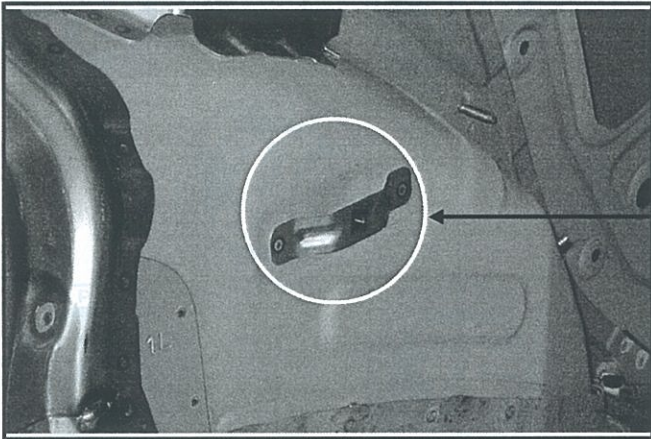

PHOTO N° 0805310_3

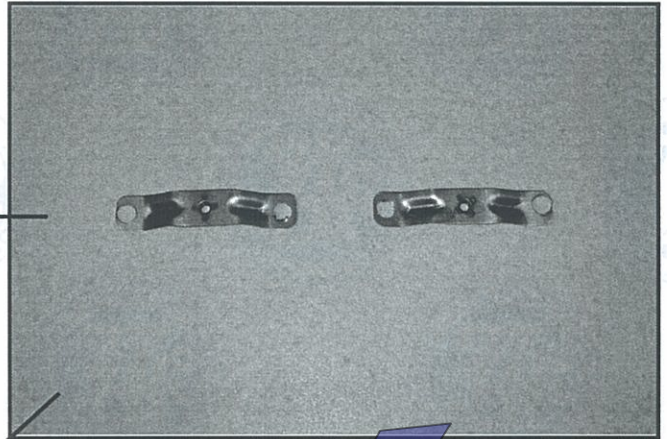

PHOTO N° 0805310_2

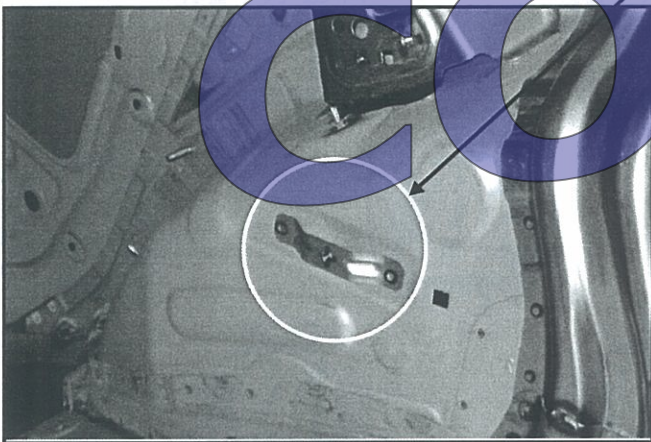

PHOTO N°

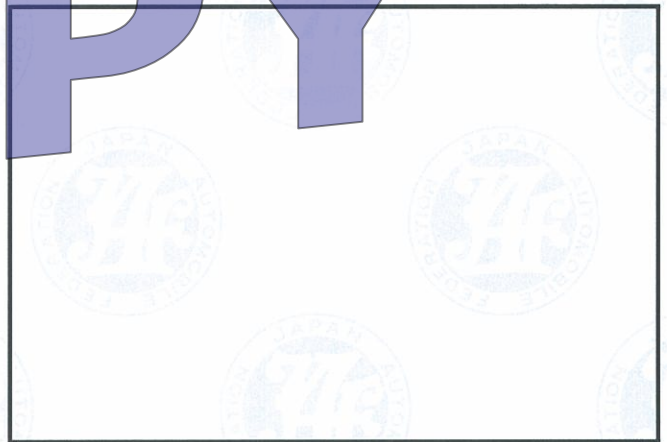

PHOTO N° 0805311_1

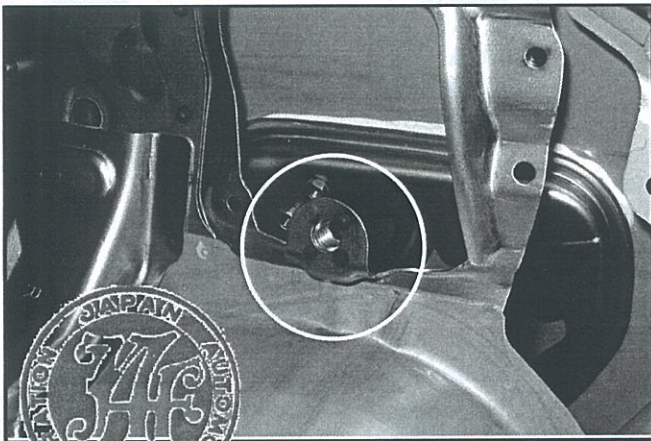
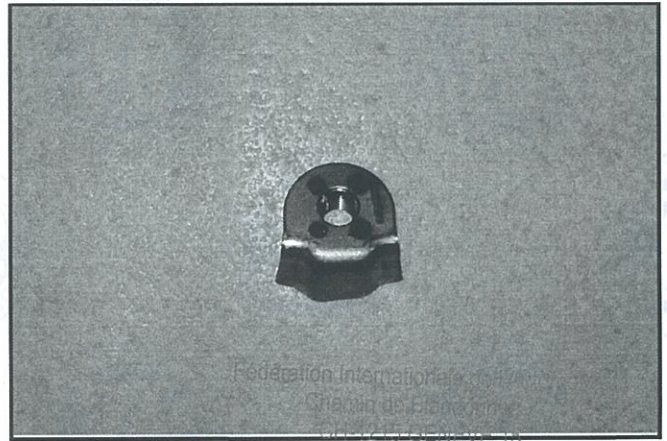

PHOTO N° 0805311_2



Marque
Make
会社名 FUJI

Modèle
Model
行名 GRB

Homologation N°

N-5714

Extension N°

08/04 VO

JAF公認番号

FN-085 VO-5/3

PHOTO N° 0805312_1

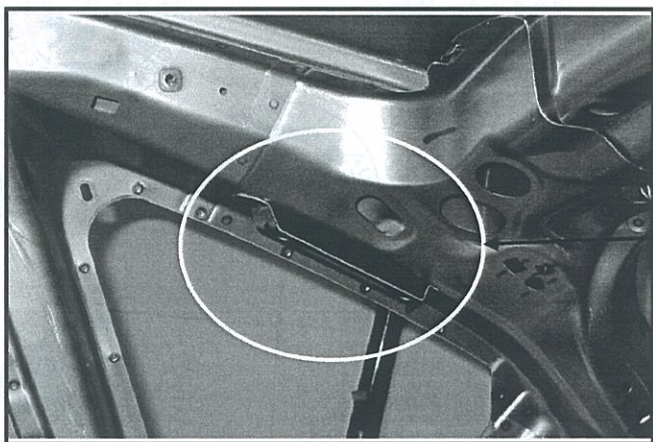

PHOTO N° 0805312_3

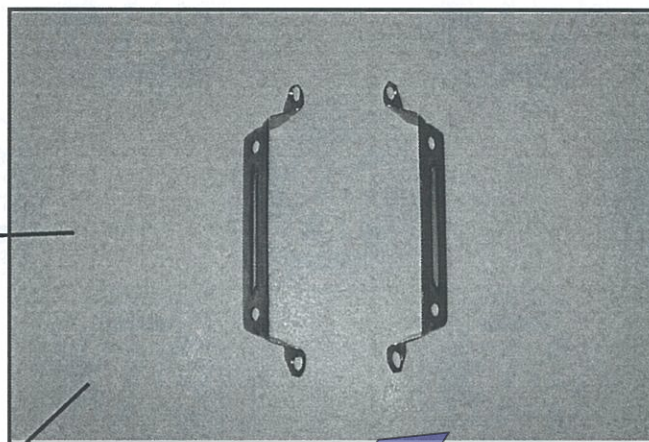

PHOTO N° 0805312_2

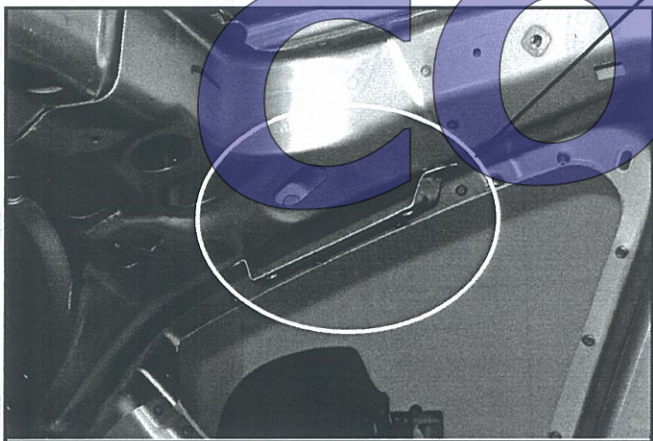

PHOTO N°

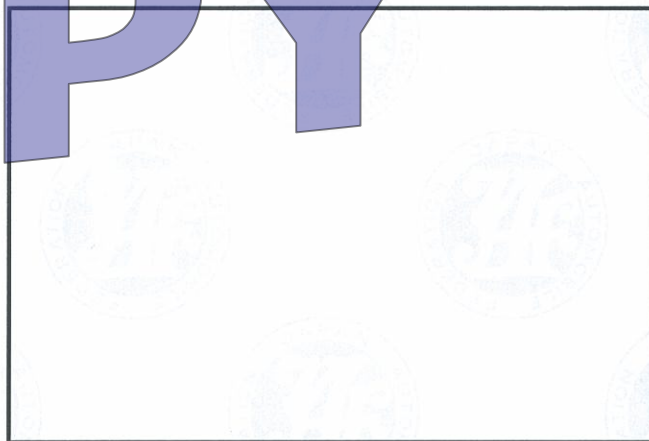

PHOTO N°

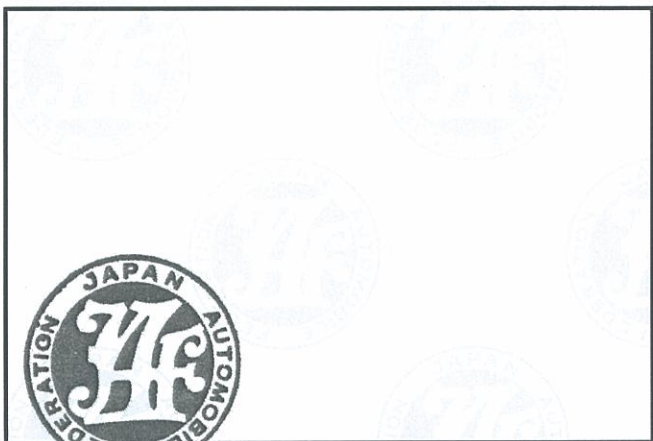
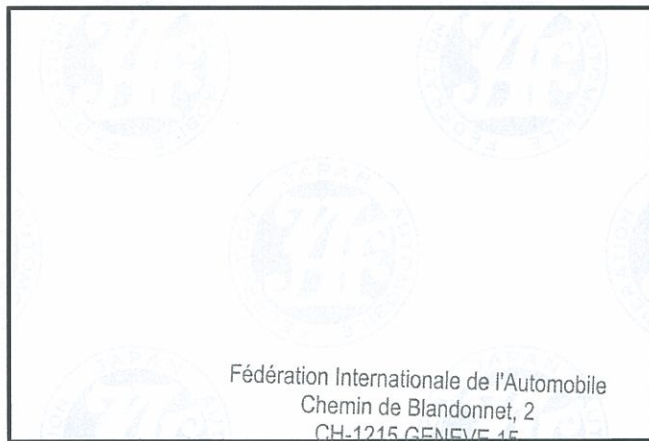

PHOTO N°



Fédération Internationale de l'Automobile
Chemin de Blandonnet, 2
CH-1215 GENEVE 15
Tél.: 41 22 544 44 00
Fax Sport: 41 22 544 44 50

Marque
Make
会社名 FUJI

Modèle
Model
行名 GRB

Homologation N°

N-5714

Extension N°

08/04 VO

JAF公認番号

FN-085 VO-5/3

PHOTO N° 0805313_1

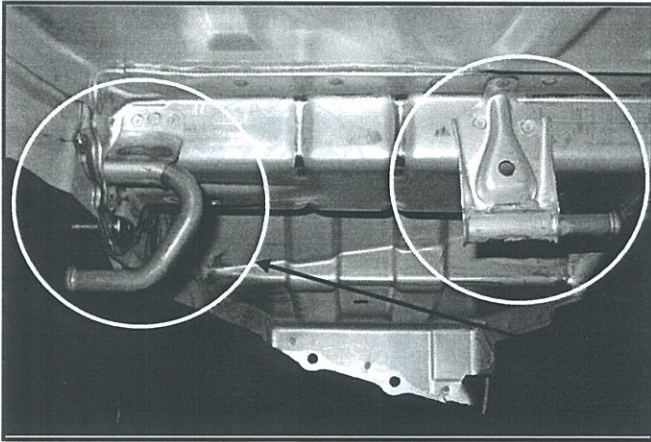

PHOTO N° 0805313_2

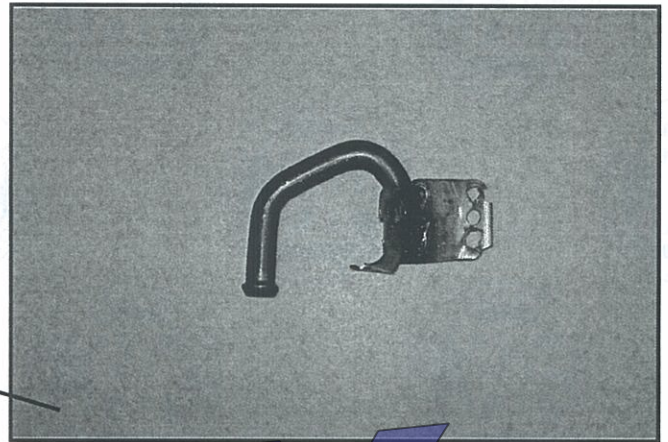

PHOTO N°

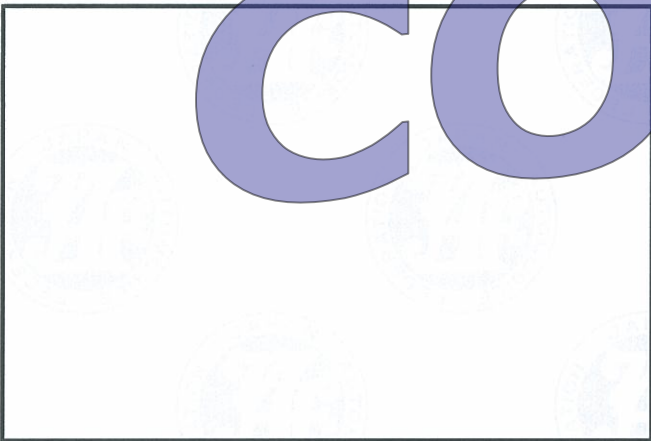

PHOTO N° 0805313_3

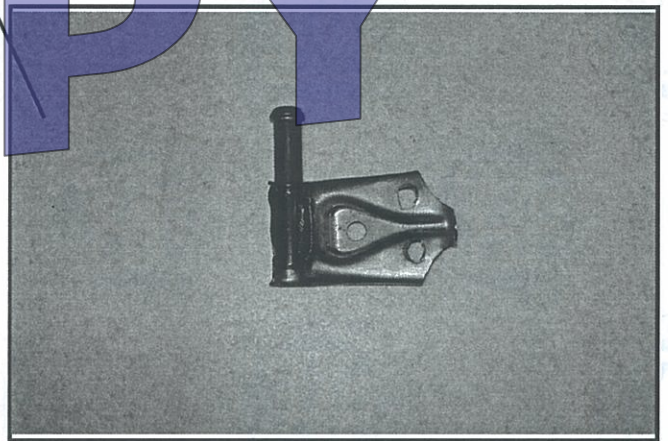

PHOTO N°



PHOTO N°



Fédération Internationale de l'Automobile
Chemin de Blandonnet, 2
CH-1215 GENEVE 15
Tél.: 41 22 544 44 00
Fax Sport: 41 22 544 44 50

Marque
Make
会社名 FUJI

Modèle
Model
行名 GRB

Homologation N°

N-5714

Extension N°

08/04 VO

JAF公認番号 FN-085 VO-5/3

PHOTO N° 0805314_1

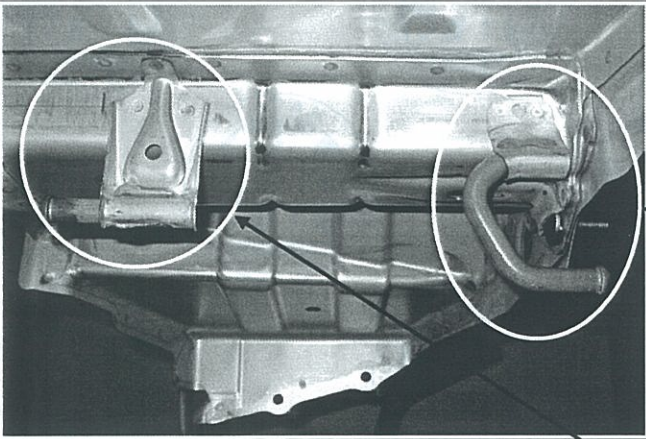

PHOTO N° 0805314_2

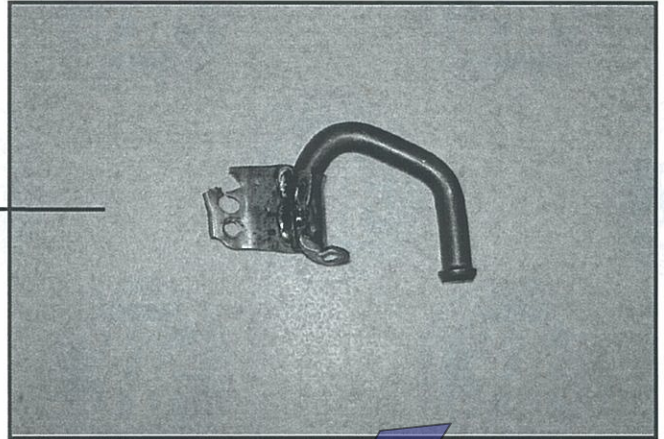

PHOTO N°

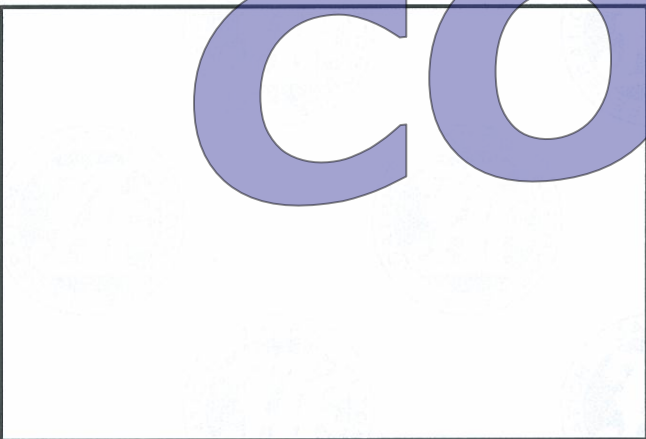

PHOTO N° 0805314_3

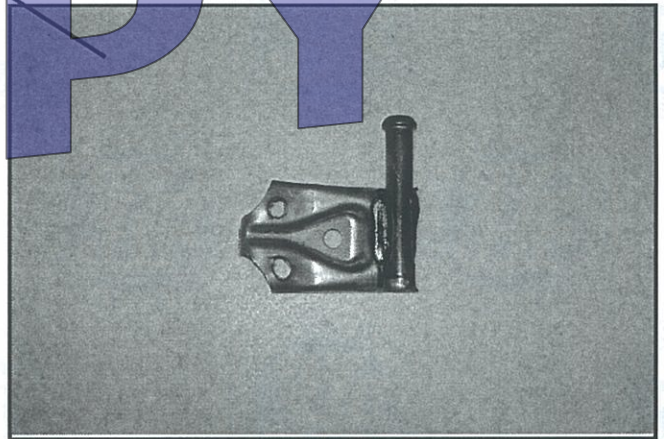

PHOTO N°

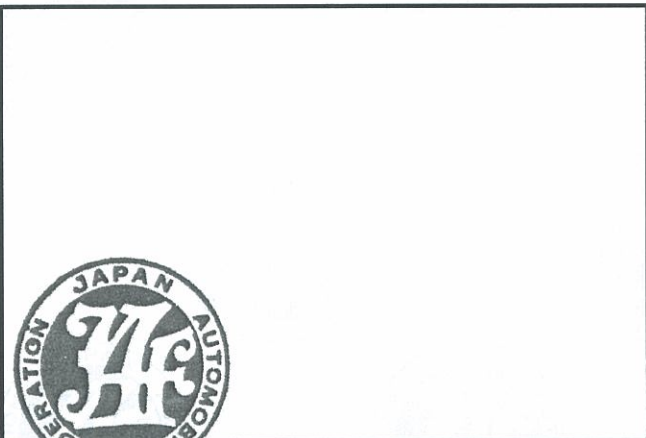
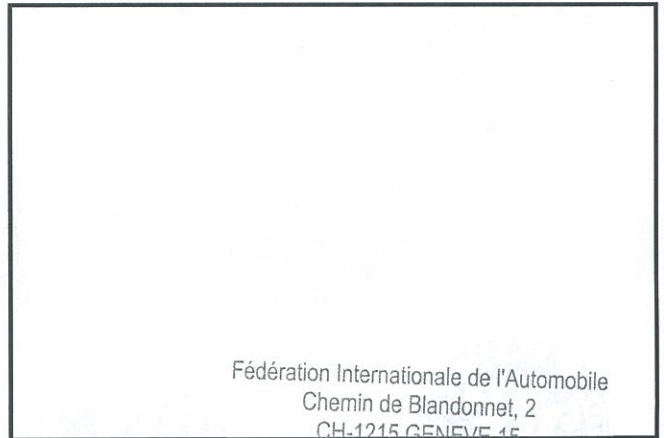

PHOTO N°



Fédération Internationale de l'Automobile
Chemin de Blandonnet, 2
CH-1215 GENEVE 15
Tél.: 41 22 544 44 00
Fax Sport: 41 22 544 44 50